

LCD Television

Service Manual

Chassis: MT9602

Version: V 1.00

Hisense Visual Technology Co., Ltd.

June 10, 2021

REVISION HISTORY

Version	Revise content	Reviser	Date
V1.00	First issued	Sun Penglin	2021-6-10

Contents

◦

Contents	- 3 -
Service Manual	- 4 -
1. Precautions and notices.....	- 4 -
1.1 Warning.....	- 5 -
1.2 Notes.....	- 7 -
2. TV boards:	- 10 -
2.1 Main board layout.....	- 10 -
2.3 TV boards part list	- 12 -
3. Factory/Service OSD Menu and Adjustment.....	- 13 -
3.1 Remote Control.....	- 13 -
3.2 How to enter the Factory OSD Menu	- 14 -
3.3 Factory OSD Menu.....	- 16 -
4. Software Upgrading.....	- 21 -
4.1 USB Upgrade.....	- 21 -
4.2 Mstar Tool upgrading.....	- 23 -
5. Trouble shooting	- 35 -
5.1 Troubleshooting for Remote Control.....	- 35 -
5.2 Troubleshooting for Function Key.....	- 36 -
5.3 TV won't Power On.....	- 37 -
5.4 Troubleshooting for Audio.....	- 38 -
5.5 Troubleshooting for TV/HDMI input	- 39 -
5.6 Troubleshooting for Video input.....	- 40 -
6. Signals Block Diagram & power assign & schematic diagram	- 40 -

Service Manual

1. Precautions and notices

BEFORE SERVICING THE LCD TV, READ THE SAFETY PRECAUTIONS IN THIS MANUAL.

USE ONLY MANUFACTURER SPECIFIED REPLACEMENT PARTS WHEN SERVICING.

USE OF NON-AUTHORIZED PARTS WILL VOID THE MANUFACTURE'S WARRANTY

Proper service and repair is important to the safe, reliable operation of all Hisense Equipment. The service procedures recommended by Hisense and described in this Service Guide are effective methods of performing service operations. Some of these service operations require the use of tools specially designed for the purpose. The special tools should be used when and as recommended.

It is important to note that this manual contains various CAUTIONS and NOTICES which should be carefully read in order to minimize the risk of personal injury to service personnel. The possibility exists that improper service methods may damage the equipment and pose risk of personal injury

. It is also important to understand that these CAUTIONS and NOTICES ARE NOT EXHAUSTIVE. Service should only be performed by an experienced electronics technician trained in the proper Television safety and service methods and procedures

Hereafter throughout this manual.

1.1 Warning

1.1.1

Critical components having special safety characteristics are identified with a ▲ by the Ref. No. in the parts list. Use of non-manufacturer's recommended parts may create shock, fire, or other hazards. Under no circumstances should the original design be modified or altered without written permission from RCA. Hisense Eassumes no liability, express or implied, arising out of any unauthorized modification of design. Servicetech assumes all liability.

1.1.2.

All ICs and many other semiconductors are susceptible to electrostatic discharges (ESD). Careless handling during repair can reduce life drastically. When repairing, be sure to use anti-static table mats and properly use a grounding wrist stra. Keep components and tools also at this same potential.

IMPORTANT:

Always disconnect the power cord from AC outlet before replacing parts or modules.

1.1.3

To prevent electrical shock, use only a properly grounded 3 prong outlet or extension cord.

1.1.4

When replacement parts are required, be sure to use replacement parts specified by the manufacturer or have the same characteristics as the original part. Unauthorized substitutions may result in fire, electric shock, or other hazards and will void the manufacturer's warranty.

1.1.5

Safety regulations require that after a repair the set must be returned in its original condition. In addition, prior to closing set, check that:

-Note:

>All wire harnesses and flex cables are properly routed and secured with factory tape and/or mounted cable clamps.

> All cables and connectors are properly insulated and do not have any bare wires/lead exposed

1.1.6

(1) Do not supply a voltage higher than that specified to this product. This may damage the product and may cause a fire.

(2) Do not use this product:

> High humidity areas

> In an area where any water could enter or splash into the unit.

High humidity and water could damage the product and cause fire.

(3) If a foreign substance (such as water, metal, or liquid) gets inside the panel

module, immediately turn off the power. Continuing to use the product may cause fire or electric shock.

(4) If the product emits smoke, and abnormal smell, or makes an abnormal sound, immediately turn off the power. Continuing to use the product, it may cause fire or electric shock.

(5) Do not pull out or insert the power cable from/to an outlet with wet hands. It may cause electric shock.

(6) Do not damage or modify the power cable. It may cause fire or electric shock.

(7) If the power cable is damaged, or if the connector is loose, do not use the product: otherwise, this can lead to fire or electric shock.

(8) If the power connector or the connector of the power cable becomes dirty or dusty, wipe it with a dry cloth. Otherwise, this can lead to fire.

(9) Use only with the cart, stand, tripod, bracket, or table specified by the manufacturer, or sold with the apparatus. When a cart is used, use caution when moving the cart/apparatus combination to avoid injury from tip-over

1.2 Notes

Notes on Safe Handling of the LCD panel and during service

The work procedures shown with the Note indication are important for ensuring the safety of the product and the servicing work. Be sure to follow these instructions.

- Before starting the work, secure a sufficient working space.
- At all times other than when adjusting and checking the product, be sure to turn OFF

the POWER Button and disconnect the power cable from the power source of the TV during servicing.

- To prevent electric shock and breakage of PC board, start the servicing work at least 30 seconds after the main power has been turned off. Especially when installing and removing the power board, start servicing at least 2 minutes after the main power has been turned off.
- While the main power is on, do not touch any parts or circuits other than the ones specified. If any connection other than the one specified is made between the measuring equipment and the high voltage power supply block, it can result in electric shock or may trip the main circuit breaker. When installing the LCD module in, and removing it from the packing carton, be sure to have at least two persons perform the work.
- When the surface of the panel comes into contact with the cushioning materials, be sure to confirm that there is no foreign matter on top of the cushioning materials before the surface of the panel comes into contact with the cushioning materials. Failure to observe this precaution may result in, the surface of the panel being scratched by foreign matter.
- Be sure to handle the circuit board by holding the large parts as the heat sink or transformer. Failure to observe this precaution may result in the occurrence of an abnormality in the soldered areas.
- Do not stack the circuit boards. Failure to observe this precaution may result in problems resulting from scratches on the parts, the deformation of parts, and

short-circuits due to residual electric charge.

- Perform a safety check when servicing is completed. Verify that the peripherals of the serviced points have not undergone any deterioration during servicing. Also verify that the screws, parts and cables removed for servicing purposes have all been returned to their proper locations in accordance with the original setup.



The lightning flash with arrowhead symbol, within an equilateral triangle is intended to alert the user to the presence of uninsulated dangerous voltage within the products enclosure that may be of sufficient magnitude to constitute a risk of electric shock.





The exclamation point within an equilateral triangle is intended to alert the service personnel to important safety information in the service literature. .

2. TV boards:

2.1 Main board layout

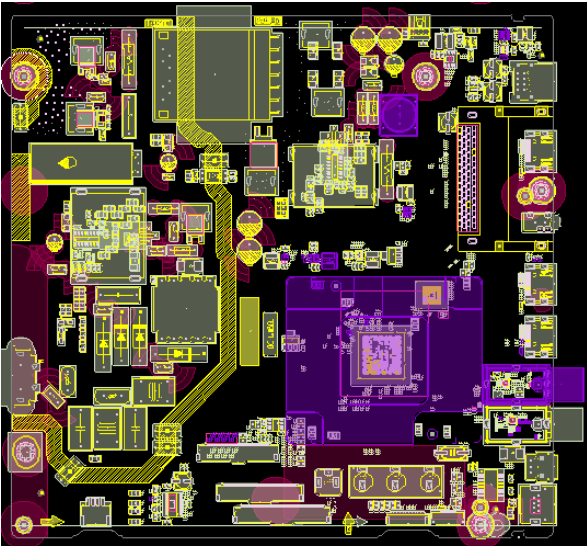
2.1.1 The top of main board (RSAG7.820.11425/ROH)



Main board 11425 terminals 



Main board 11425 power tree:

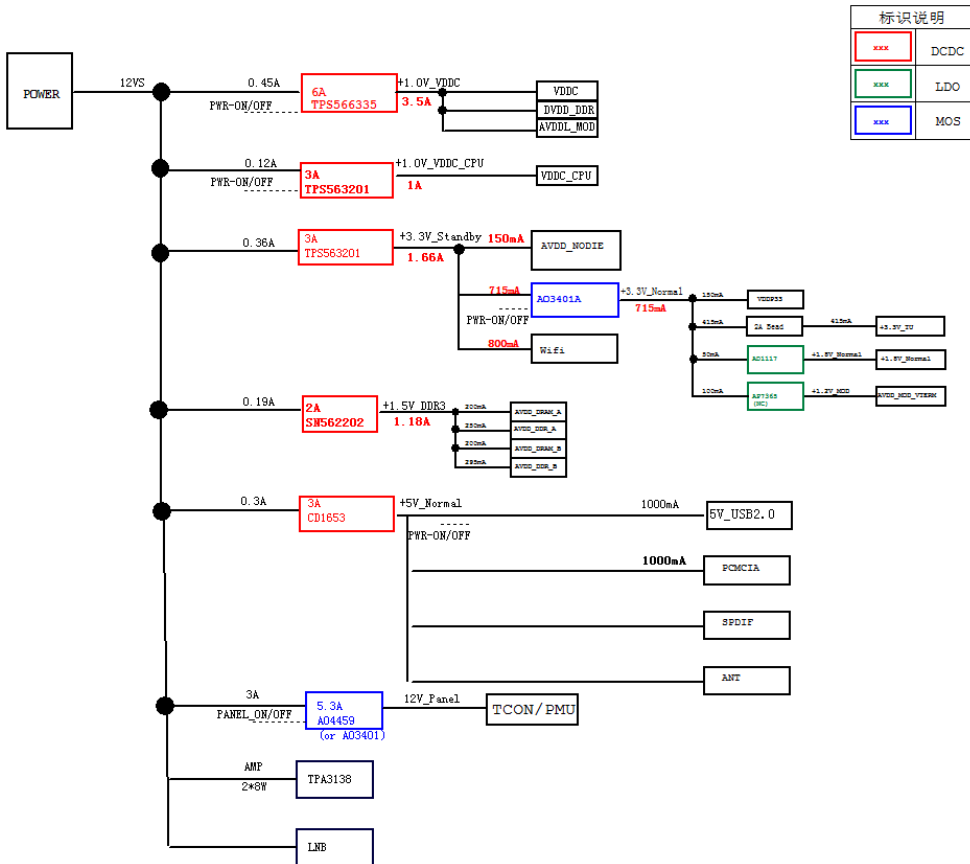

Main board 11425 sign block diagram:

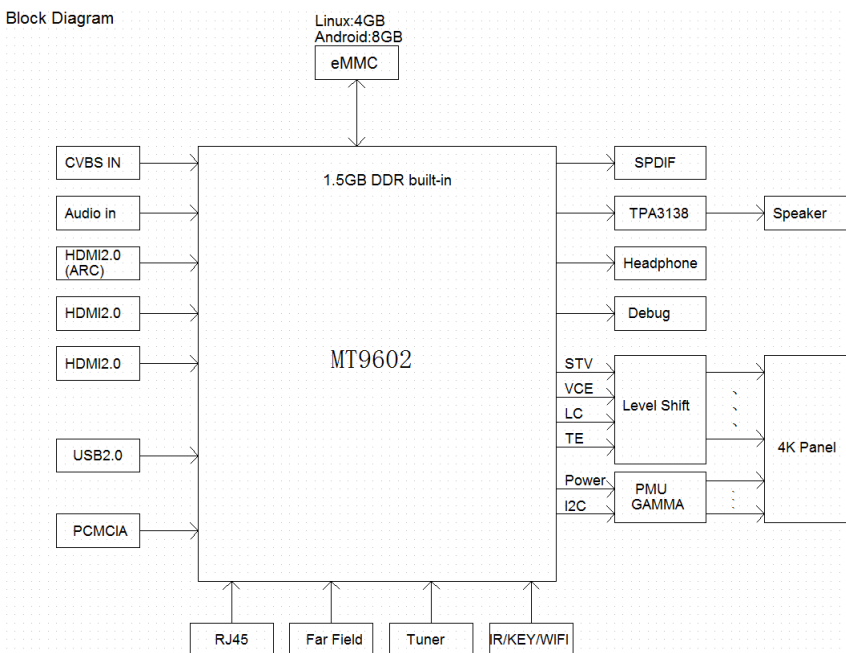

2.3 TV boards part list

Main board	Boards function difference	Main chassis type	For Series
RSAG7.820.11425\RO H	Lateral terminal and vertical terminal. Main board Power parts complex board	MT9602	50A53FEVS(0004)

3. Factory/Service OSD Menu and Adjustment



3.1 Remote Control



Different customer the logo maybe have difference.

3.2 How to enter the Factory OSD Menu

. With user's RC

1. Power TV on
2. Press  button to select any one source and press  button on the RC then call up "Menu" option. Figure-1
3. Select **Sound-Mode**> **Audio output setting** -> **Balance** Figure-2 Figure-3
4. On the **Balance**, input figure 1->9->6->9 in sequence on RC. Figure-4

Note: It is important to remember that the hand fingers can't shield the RC emitter diode.

5. Call up a "M" on the left-top of TV, then press  button again, the Factory menu appear then.

6. DC power off and DC power on the TV, which can exit Factory OSD.

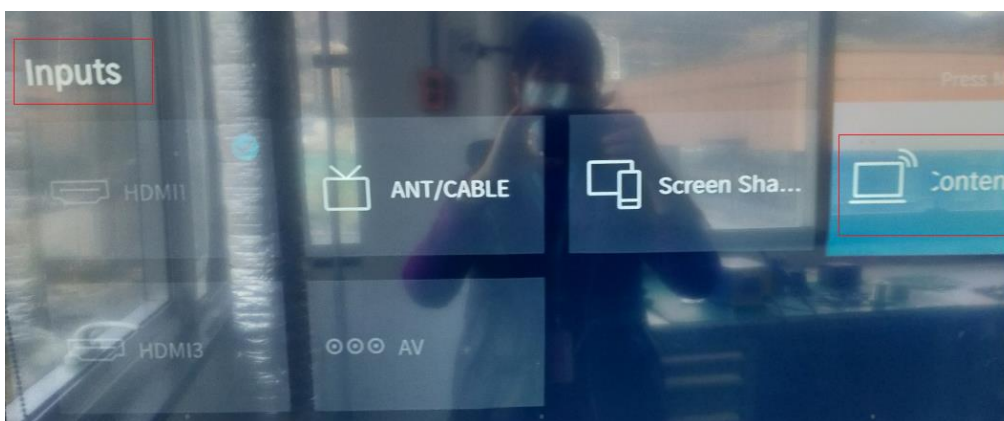

Figure-1



Figure-2

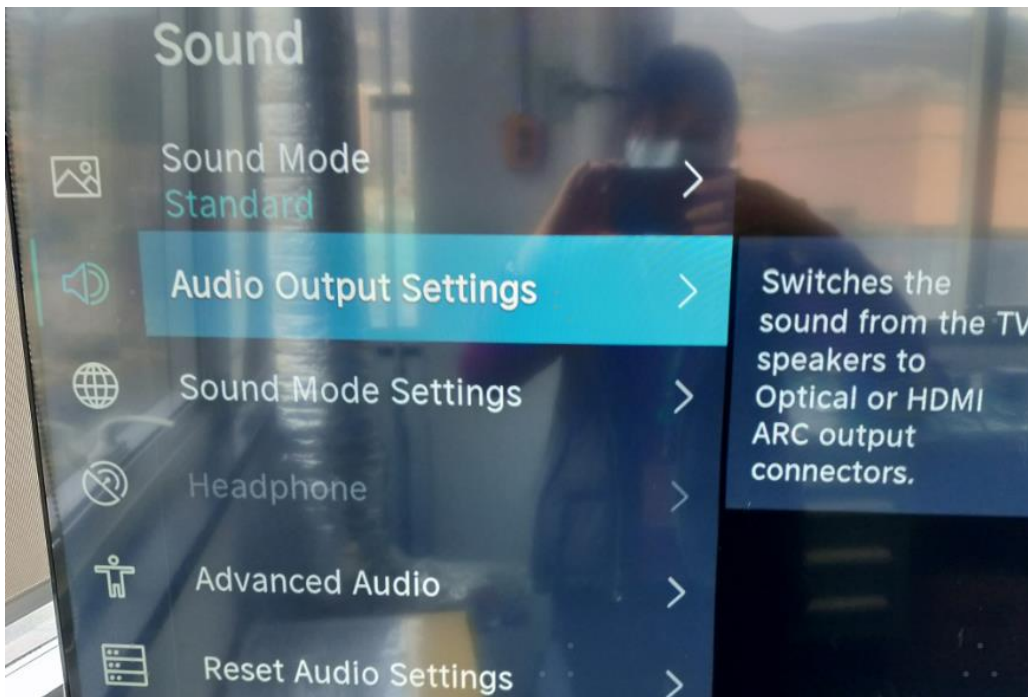

Figure-3



Figure-4

On the **Balance**, input figure 1->9->6->9 in sequence on RC.

3.3 Factory OSD Menu

1、 If you want to learn more about TV, you'd better read Factory OSD menu list but would not adjust the value please. The Factory menu may be have difference for diverse market and customer. Take 50A53FEVS(0004) for example.

2、 Check whether the Key information under the current Version is OK, if appears “NG” or such as following red surround irregular information then need rewrite the key.

MAC : 74:72:B0:28:03:4A

Widevine : FFFFFFFF







Netflix : 0xFFFFFFFF

HDCP 1.4 : 04198088







HDCP 2.2 : 00995406

CI+ : 00034583

	Factory menu	Description	Remark
Menu	White Balance	White Balance data adjusting, different source has different WB values. Before adjusting, please change to desired source.	
	channel init	TV Produce signal preset, during the factory produce using.	
	Option	Items can choose	
	Soft version	current software version information	
	Write keys	Write key	
	Version	TV software information	
	MAC Address	MAC address information	
	Cur project ID		
	WIDEVINE key	WIDEVINE key code	
	HDCP1.4 key		
	HDCP2.2 key		
	ESN	Code information	

White Balance	BIN B1 	can choose B1/B2/B3/B4/B5/B6
	R Gain  128	High Brightness Red
	G Gain  128	High Brightness Green
	B Gain  128	High Brightness Blue
	R Offset  128	Low Brightness Red
	G Offset  128	Low Brightness Green
	B Offset  128	Low Brightness Blue

Channel init	Huang Dao	
	Qing Dao	TV Produce signal preset, during the factory produce using.
	Gui Yang	
	

Option	ToFAC M/U 	"M" used in factory product. "U" used in user state.
	Clear All	
	Region	
	country 	Country choose
	Logo 	Customer logo choose
	Language 	Language choose
	UART 	On/off (when choose "on" then can serial port connect with Tool successfully)
	PQ COM 	On/off

Write keys	MAC	If MAC key code lost, you can write.
	HDCP2.2	If HDCP key code lost, you can write .
	HDCP1.4	If HDCP key code lost, you can write .
	Netflix	If Netflix key code lost, you can write .
	Widevine	If Widevine key code lost, you can write .

Note:

The Factory menu may be have difference for diverse market and customer, above Factory menu only for reference.

The factory menu data varies according to different sources. Incase changing the factory data by error, you can choose to “Clear Unprotectly”, by which you can resume the default value.

To clean the EEPROM:

- a. Select the item “**Option**”--“Clear all” in Factory mode.
- b. Press > button to clear the EEPROM data.
- c. Close the OSD menu after 5 seconds.
- d. Restart the TV.
- e Also the Keys information must been checked, if appear “NG”, then must rewrite key code.

4. Software Upgrading

4.1 USB Upgrade

Main software upgrade directly with USB

The main software can be upgraded with USB disk. It includes two modes: user mode、 factory mode. Take **50A53FEVS(0004)** for example.

4.1.1 TV in user mode:

- a. Decompress MTK_DEV_US_pkg_YYYYMMDD.tar.gz (YYYYMMDD is the year/month/day/hour/minute when the software is being built, such as MTK_DEV_US_(4K_)pkg_20200321.tar.gz), then change usb_XXX.bin file name to “MstarUpgrade.bin” and the bin file to the USB root directory. Please make sure there are no other “*.bin” files in the root directory of USB disk.
- b. AC power off the TV, insert the USB disk, AC power on and long press the “power” key . If “upgrading software not turn off.....” is shown on TV, it means TV successfully enters upgrading status. Upgrade process bar will indicate the progress. It needs about 8 minutes to complete the whole software upgrade.
- c. After upgrade, TV can automatically reboot.
- d. Enter the Factory OSD Menu to check the main software version, and then choose “option”→“Clear all” to do clean up.

4.1.2 TV in factory mode:

- a. If TV is in Factory mode, only have difference from chapter 4.1.1 b. as following. others are same.
- b. TV is in factory mode, only AC power off TV and insert the USB disk, next AC power on, TV can identify automatically to update, till call up “upgrading software not turn off.....” interface, Upgrade process bar will indicate the progress.ni

4.1.3 If the above USB upgrade methods fail, you can use serial “cu” to update.

4.1.4 When upgrade successfully, We must ensure the TV mode of running correctly.

Paths: Factory MENU

Once choose another TV mode, must AC power off and power on the TV to reboot.

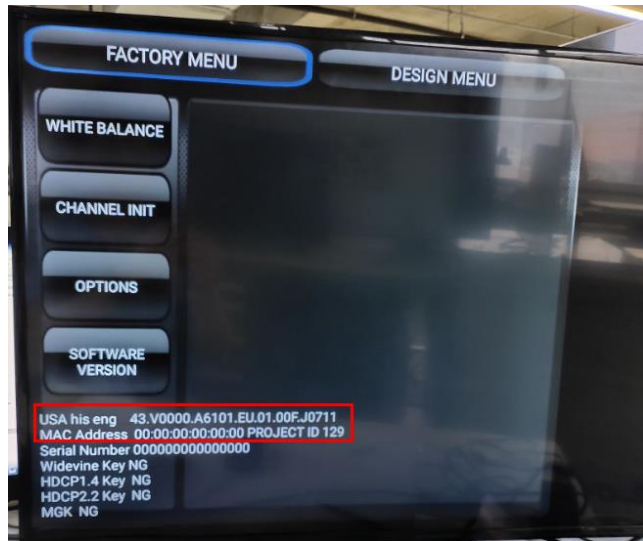

Figure-1: upgrading software

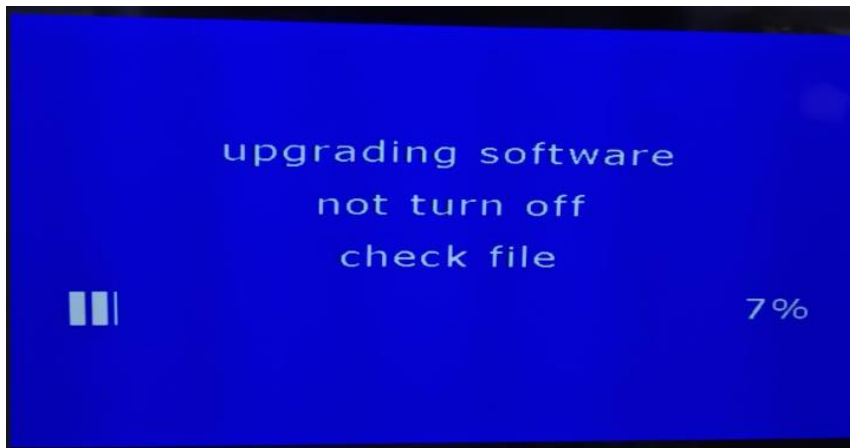

Figure-1

Figure-2 : Software upgrade complete,TV automatically reboot.

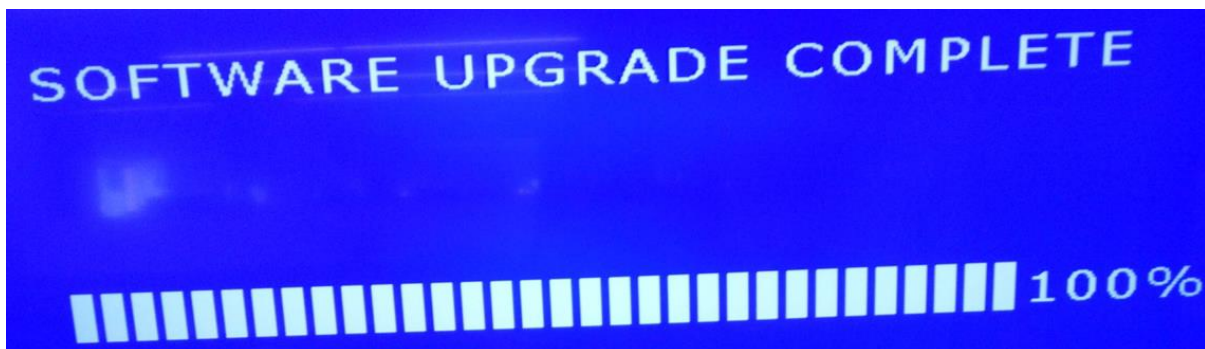

Figure-3

4.2 Mstar Tool upgrading

If USB upgrades failure, TV crashed and SecureCRT no print message. Repairer must read IC device ID code 、 decipher& burn the Mboot program the EMMC flash first. then USB disk to upgrade the“upgrade_loader_no_tvcertificate.pkg “file.

Hardware connecting

Connect the unit to your pc with Hisense USB-serial port cable. USB port connects to your PC and earphone port to TV’s CN7(earphone hole). As following.

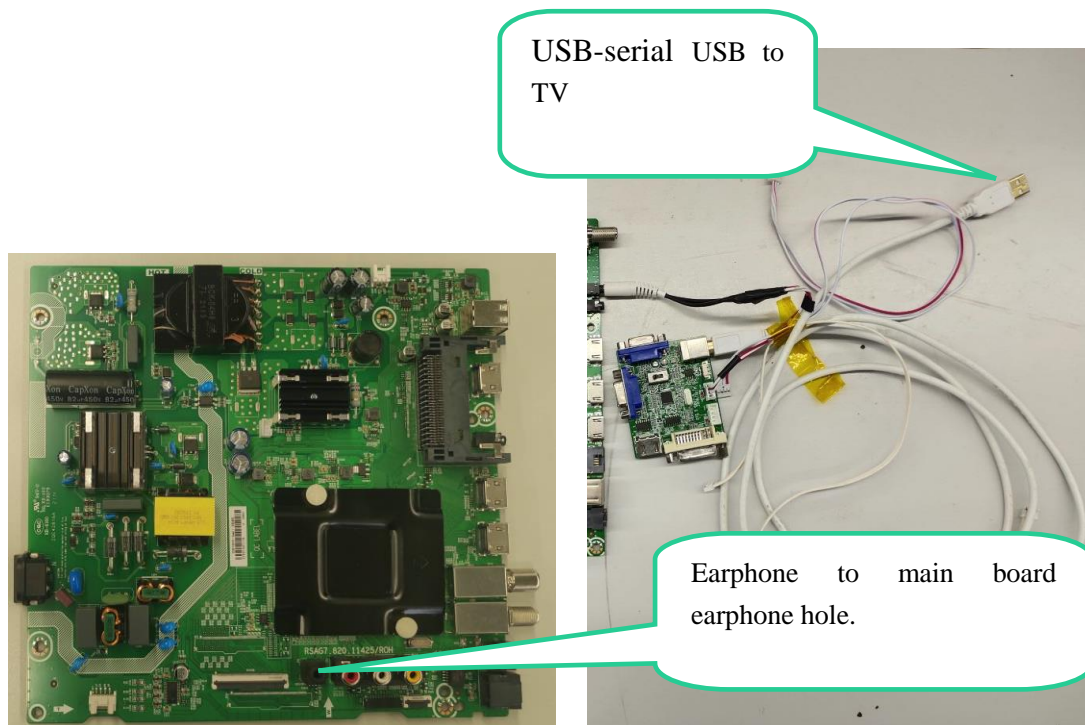

4.2.1 Open the UART serial option

UAR serial choose “on “

Menu: Factory MENU-->Options-->Uart Switch-->on

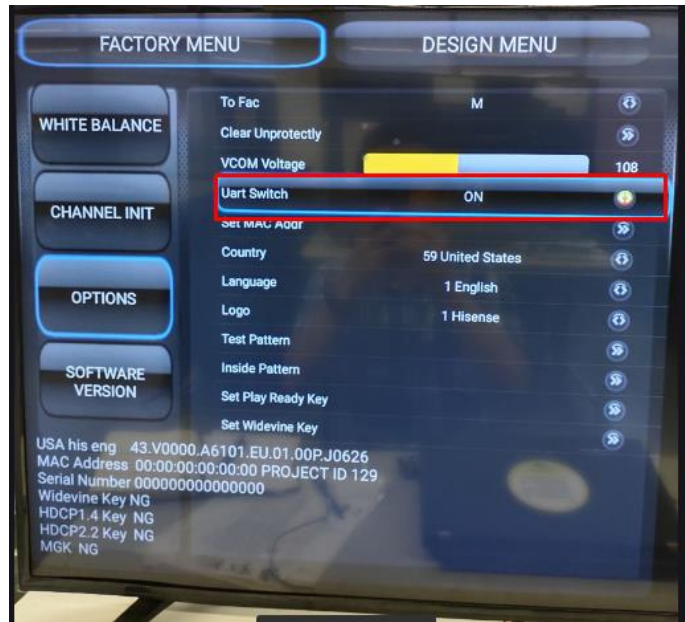

If finish the updating and data adjust UART serial, Uart Switch choose “off “

4.2.2 Mstar USB-serial driver

If First use Mstar bebug Tool, you have to install drive software for bebug board.

If your PC is Windows XP system:

First install FTCUNIN.EXE of FTC100103(MSTAR) rar file in your PC.

This is a drive software of Mstar



Another:

If your PC is Win7 system, you will have to install CDM20802_Setup_WIN7 rar file, and then open the software of SecureCRT in your PC.

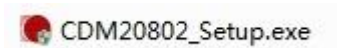

4.2.3 Stop board serial connect with SecureCRT

Run SecureCRT,printing information includes three status:Mboot\Supernova\no print information.

Current steps:

- 1) Run SecureCRT.exe
- 2) TV power on.
- 3) SecureCR tool print information can appear or not.

How to distribute the three status?

- 1) appearing “<< MStar >>#” that meaning is in Mboot status;

-
- 2) Rolling many information automatically that meaning is in Supernova status;
 - 3) No any print information that meaning the eMMC of board is no program.

Stop board serial with SecureCRT

- 1) In mboot status:

<< MStar >>#

Input “du” and “enter” key to ensure, then close the SecureCRT window.

- 2) In Supernova status:

Input “00112233”and “enter” key to ensure, then close the SecureCRT window.

- 3) If no any print information with SecureCRT,then can directly close the SecureCRT window.

4.2.4 How to collect log files

- 1) TV AC power on
- 2) USB connect correctly
- 3) Mstar serial Tool connect correctly
- 4) When questions appear , computer run SecureCRT input lowercase ” getlog” ,if fails input another”05328087”.then rolls the lots of log print message.
- 5) Save the log print message to soft engineer.

4.2.5 Mstar Tool upgrading

Mstar Tool upgrading includes two states: one is TV board has had Mboot software,the other is TV board have no Mboot software.

TV board has had Mboot software:

If TV board has had mboot software already, now need update a new one. It is important to stop serial port at first. as following.

Run the SecureCRT ,Pressing the “enter” key and at the same time AC power on the TV, then get into mboot interface to

appear <<MSTAR>># promoting character.

Behind the <<MSTAR>># input “du” then “enter” to ensure.

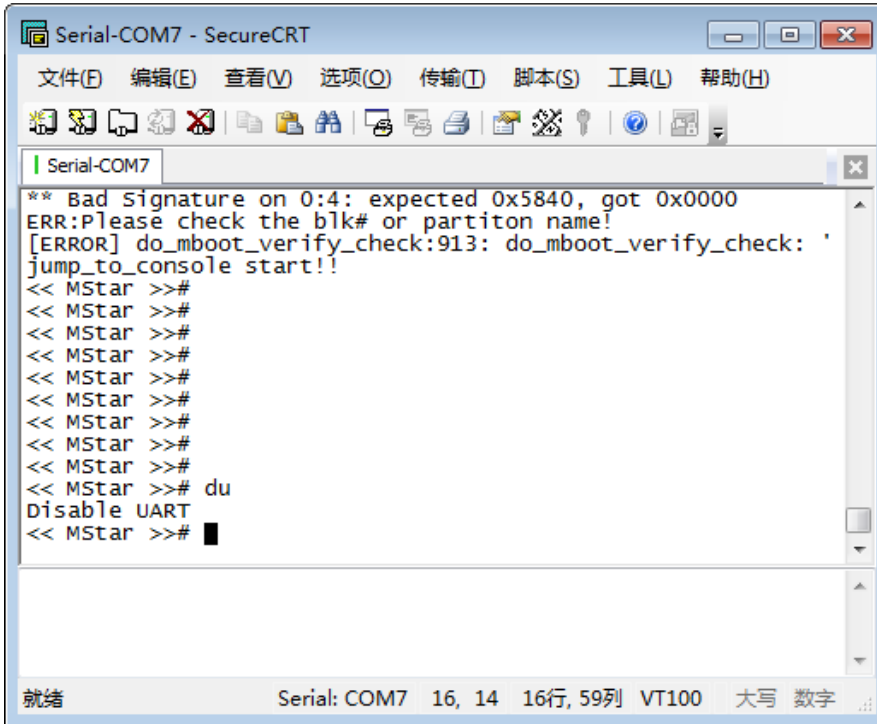

How to get the Device ID password?

- Connect the board with PC via to Hisense debug tool,With MSTVTool4.163 , run MSTV_Tool.exe



- Ensure “” button connected correctly, then click "Show DeviceID"button, you will get device ID like 0003C0701F4447FBFB0A03.

Read more again to contrast the IC Device whether has change.

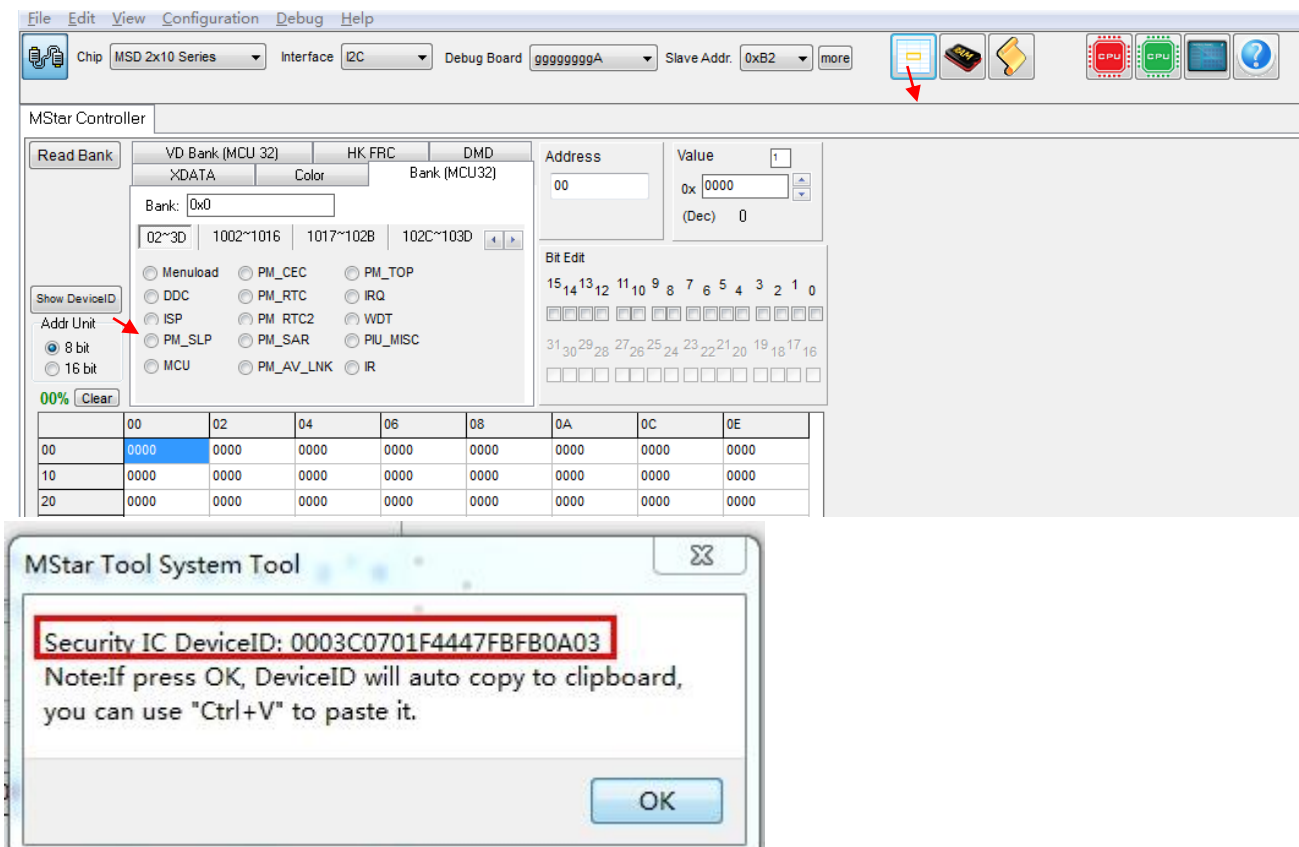

- Send the device ID to the IC developer , MSTAR max-sc lv(吕思成) max-sc.lv@mstarsemi.com securitysecurity@mstarsemi.com _Waiting for the feedback of ID password.

Deciphering

Method 1

- Use MSTV_Tool_4156_258303 tool ,run MSTV_Tool.exe, Click "Show DeviceID"button to inspect the Device ID.
- Click “View”->“Open DebugPort” choose “3rd generation input”, input the ID password from the IC developer then click “Run”

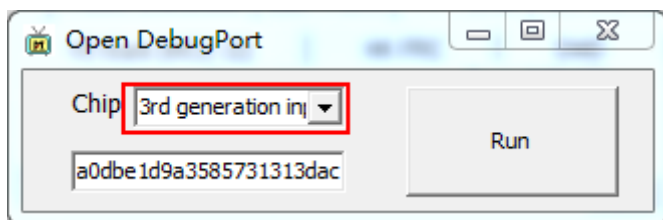

Click” Run”

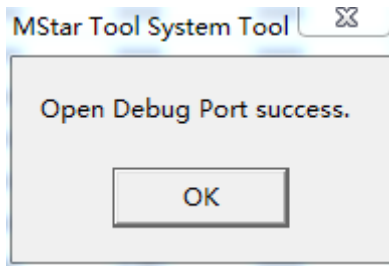

Method 2

Store the Device ID

When click "Show DeviceID" button, you can get device ID. Next click "OK" button to copy; Open the "Password.txt" file in the same direction of "MSTV_Tool.exe" to stick the Device ID.

Password .txt file

名称	修改日期	类型	大小
DeviceID.txt	2017/2/28 17:14	文本文档	1 KB
MSTV_Tool.exe	2016/10/3 15:13	应用程序	3,432 KB
MSTV_Tool.INI	2017/2/28 17:37	配置设置	2 KB
Password.txt	2017/2/28 9:24	文本文档	1 KB

```

0003715D50D70858A93E1B
0003F105CD58D460FEBA26
0003D07C202E4D1A62970C
0003D7B851DAA9F1AE9303
0003509D5007F067516F3C   EBB5ED0A10502A166EAE766F44930E25
00034B077DAD2258582236   B6EE7E8664B1B5DF4CD9C70D2F7994C8
0003DDCFE0F6A22542B9FC   13D854D1C16F1A2B1473E5A214FE3F7E
00036559D3E21FEF5E9C0C   FOE887854BBC13209A56D843F20971F6
0003A385B1438FF35B0AED   D8A2174ECAE759EF704FDB0BEBC5CE23
0003CB570D78D00FB0F8EE   41A4CF903A44A840EB2102872C862640
00036CA5D2B56329C4807B   B5E0974B524A897949E9566644D20228
000300D5C97FEDDC20F6DB   6A3FB758D024AC5E2AD263A6773D0EC1
0003D15DE8BC2C3DFDFE08   3413074DA572FD563982DB0A7FB11FD7

```

- Send the device ID to the IC developer, MSTAR max-sc lv(吕思成) max-sc.lv@mstarsemi.com securitysecurity@mstarsemi.com Waiting for the feedback of ID password.

3、Deciphering

Receive the Device ID password ,copy it into the password.txt ,as following.

```

0003509D5007F067516F3C   EBB5ED0A10502A166EAE766F44930E25
00034B077DAD2258582236   B6EE7E8664B1B5DF4CD9C70D2F7994C8
0003DDCFE0F6A22542B9FC   13D854D1C16F1A2B1473E5A214FE3F7E
00036559D3E21FEF5E9C0C   FOE887854BBC13209A56D843F20971F6

```

Click " enter password" button then bounce "success" window, it indicates deciphering succeed.

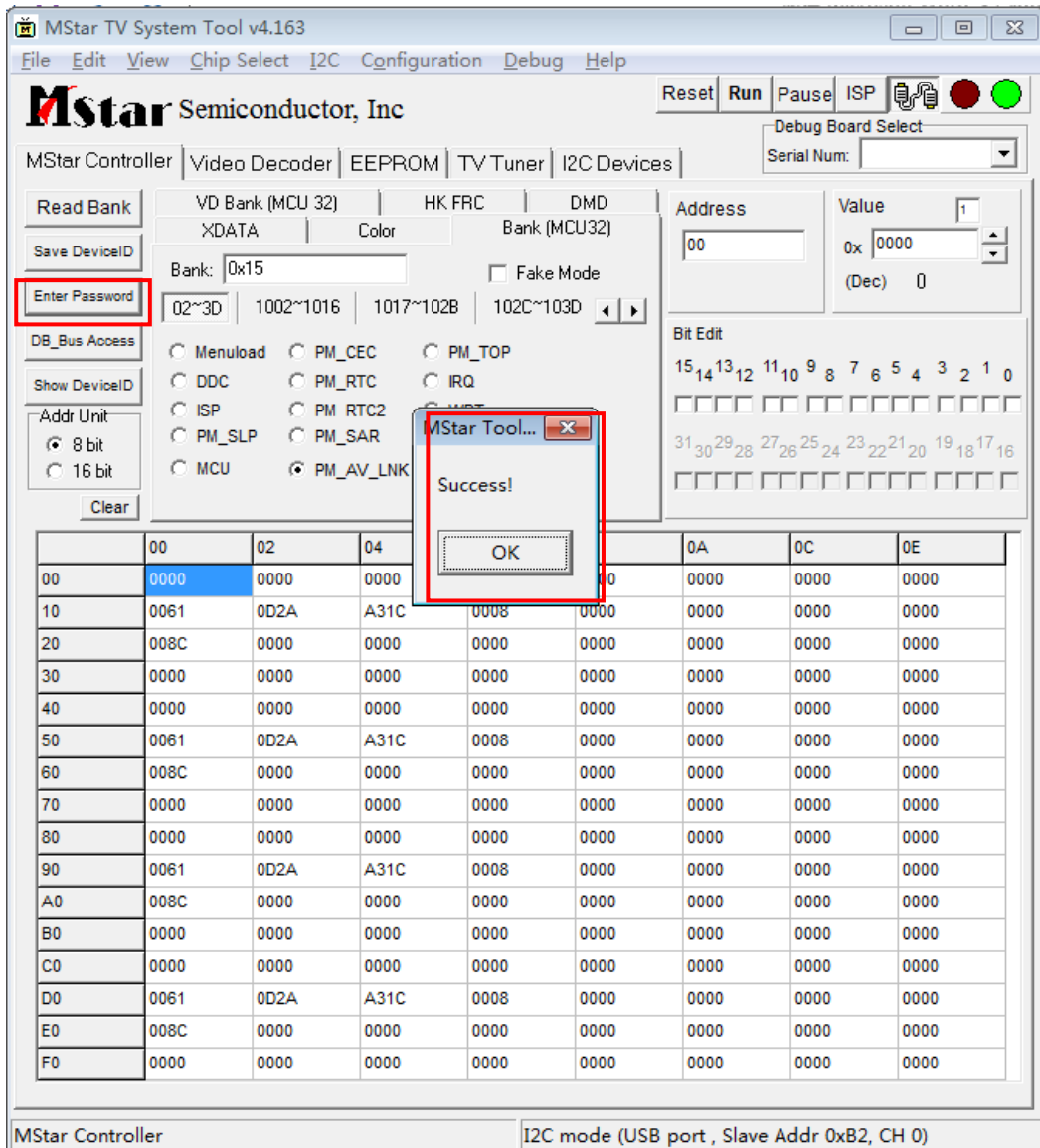

Click “Help---Product Key”, enter “security”

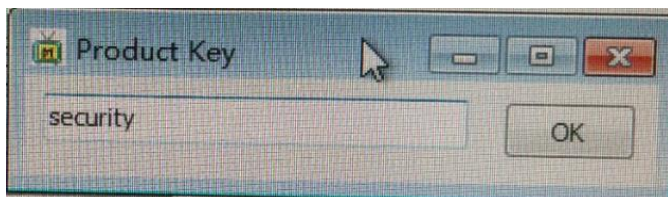
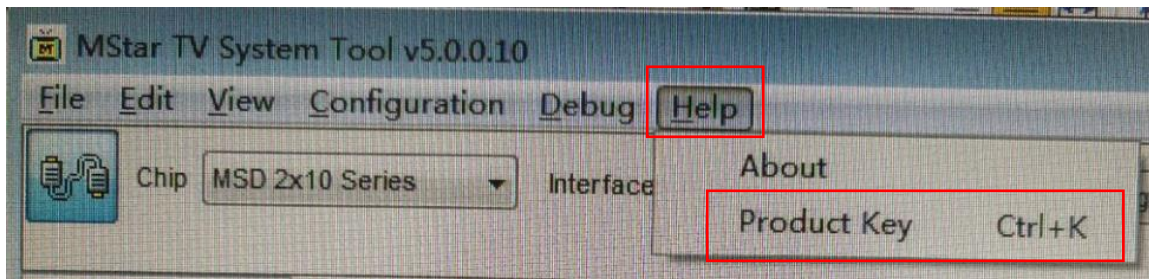

Click “Flash Update Mode”

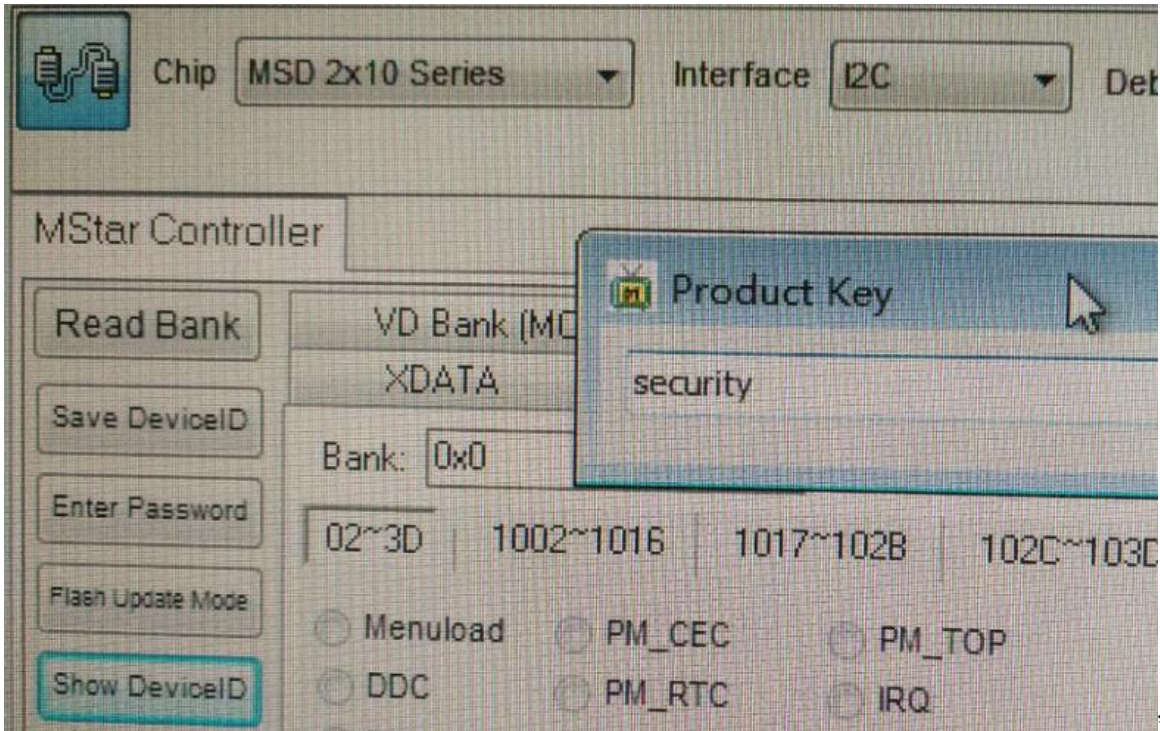

Now Deciphering has finished, Don't restart the TV .

3) Burn the mboot software with ISP_Tool_5.0.2.

Click "SPI" then click "Connect", drawing "✓" in front of "program /Exit ISP/Read file"

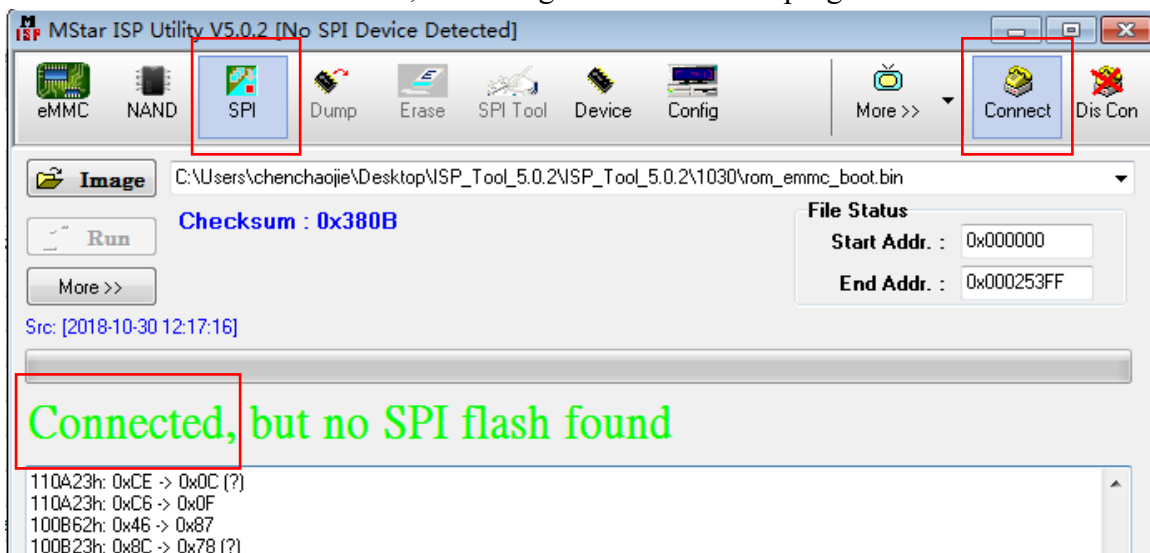

Click “eMMC” then click “More>>”and load following four burning files.
 Respectively graphic as following:

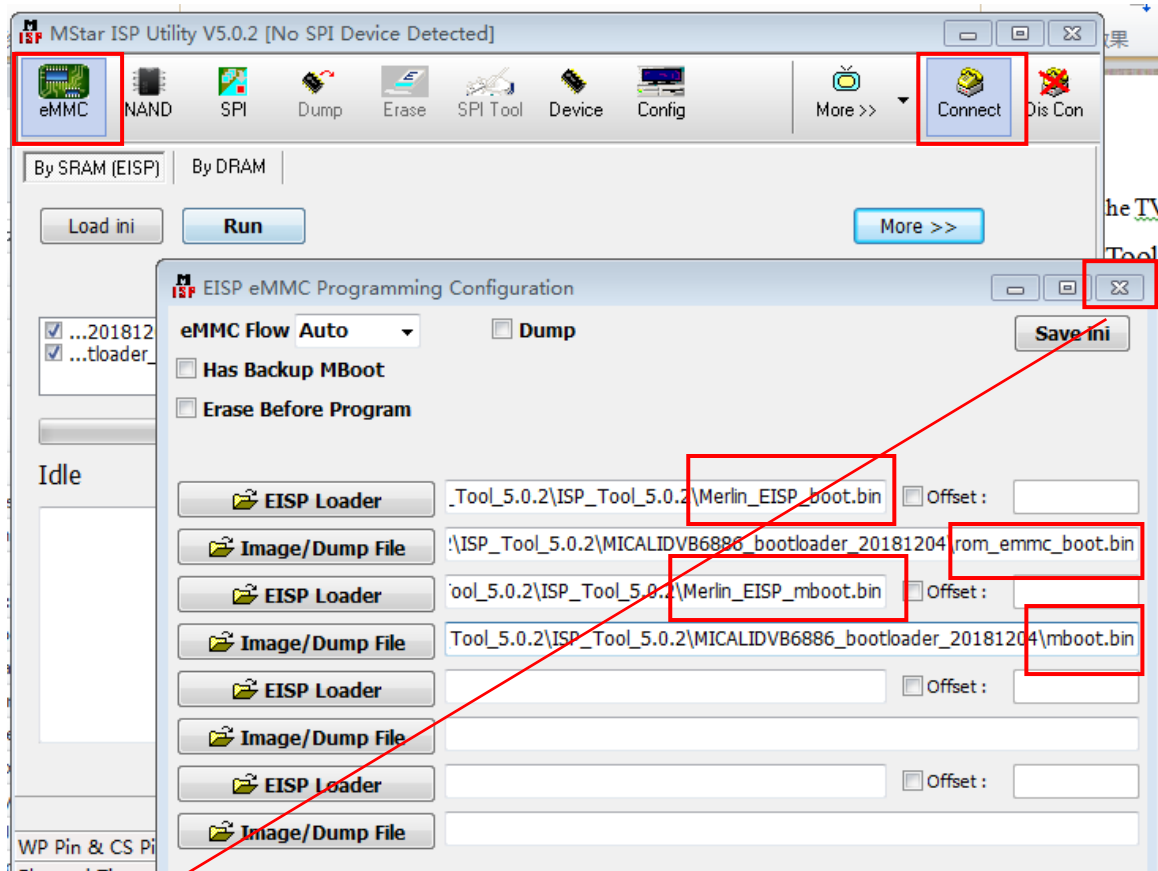

Click “X” button to close and save this setting.

“I2C speed setting”choose around 30 ,roughly speed around 200KHz, roughly speed not high otherwise can cause updating abnormality.

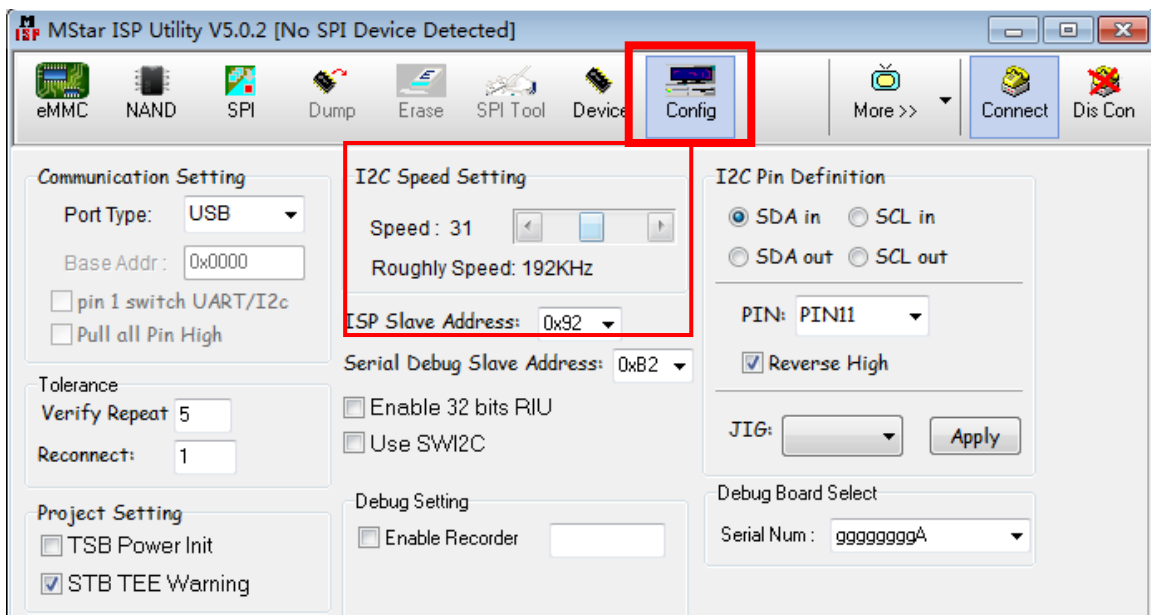

Return to “eMMC”. Then click RUN button to go on.

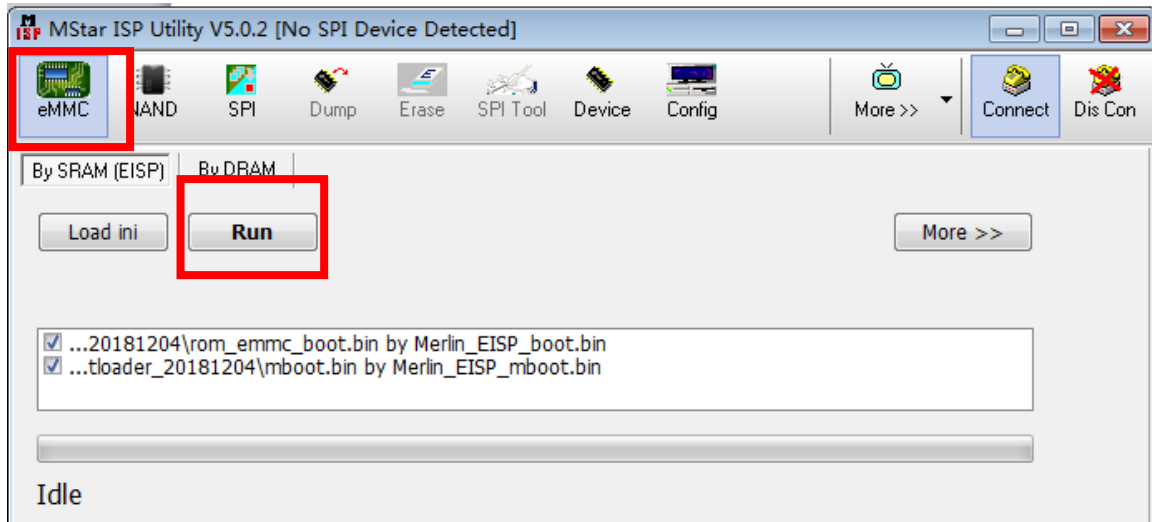

Waiting for about 8 minutes, a green “Success to program” appears on the screen, indicating upgrading successfully.

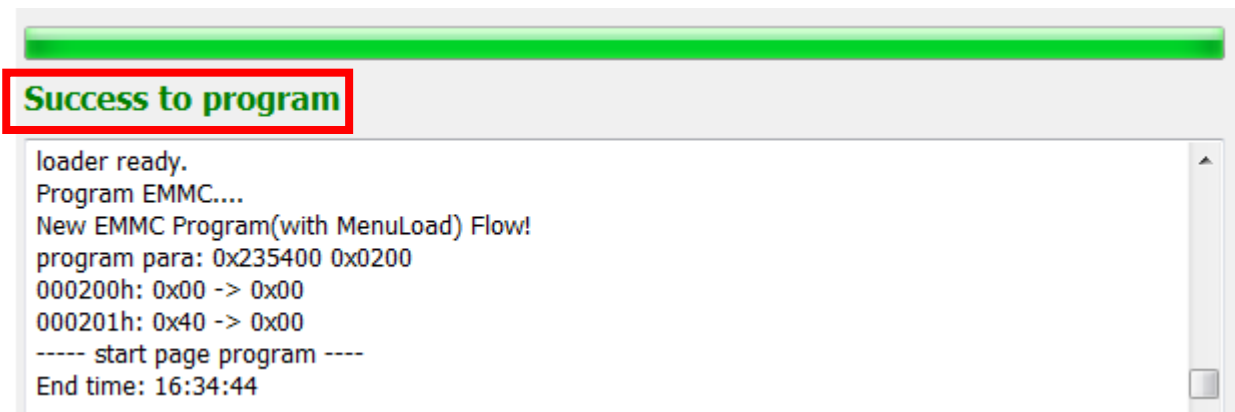

TV board have no mboot software:

Run SecureCRT , AC power on the TV. If nothing appears on screen then can indicates that the TV no Mboot software, next close the SecureCRT window directly.

4.2.5 USB upgrading

Copy the main software “upgrade_loader_no_tvcertificate.pkg” to the USB root Disk, ensure there are no other “*.pkg” files in the root directory of USB Disk.

Run the SecureCRT ,Pressing the “enter” keypad and at the same time AC power on the TV, then appear mboot interface.

```

MStar >>#
<< MStar >>#
<< MStar >>#
<< MStar >>#
<< MStar >>#
<< MStar >>#
<< MStar >>#
<< MStar >>#
<< MStar >>#
<< MStar >>#
<< MStar >>#
<< MStar >>#

```

Default find & grep make ui setenv serverip

Input lower-case letter “cu” then “enter” to update the main software.

```

** Find MBOOT **
** Find MPOOL **
** Find MBOOTBAK **
<< MStar >># cu

```

就绪

MSD6586_... 内置1GB 1167365

When main software update successfully, the TV can automatically restart. enter the Factory OSD Menu to check the main software version, and then choose “option”→“Clear Unprotectly” to do clean up.

4.2.6 Next to check the Key information under the current Version whether is OK , if NG must rewrite key code.

4.2.7 Before upgrade , write down the white balance data of different signal source.

4.2.8 Reset the Options of out of Factory if lost ,such as Region\Country/logo/language

4.2.9 Common error

- 1、 Reading Device ID have different ID codes.
 - Check the SecureCRT window whether close.
- 2、 When input key, appear” Input format Error”
 - Check Mstv_tool --open debugport -- “**3rd generation**” whether selected .

3、ISP_Tool connected failure

- Close the SecureCRT, check whether “✓” in front of “UseSWI2C” of “Config” .

4、If ISP_Tool connected appear error “ Device not selected,yet”;

- Reduce the **I2C speed setting** figure lower “Roughly speed” about “200KHz” and have a try.

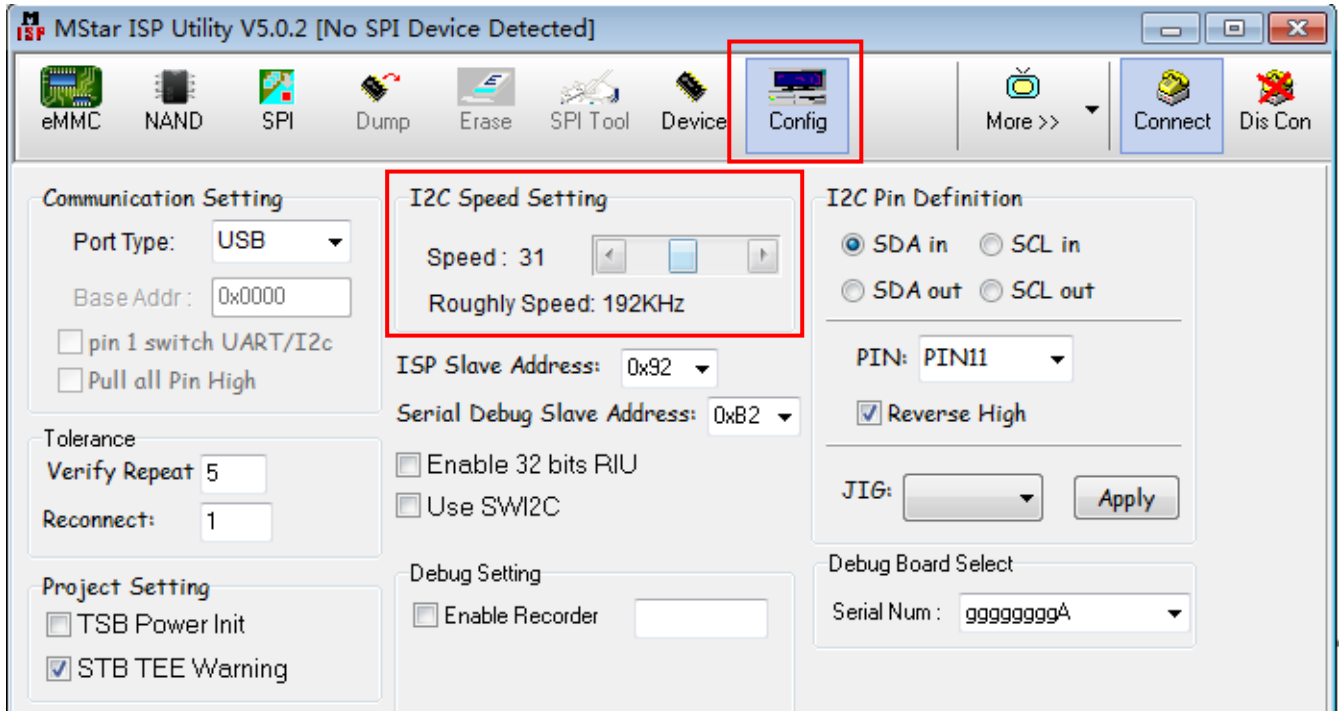

5、After USB upgrade, appear “mtdoops: mtd device (mtddev=name/number) must be supplied, Kernel panic - not syncing: VFS: Unable to mount root fs on unknown-block(179,4)”

Reason: After burn mboot and before USB upgrade, forget to clear the zone schema.

- Don't burn mboot again, ONLY restart TV with “cu” demand to USB upgrading again in mboot .

5. Trouble shooting

5.1 Troubleshooting for Remote Control

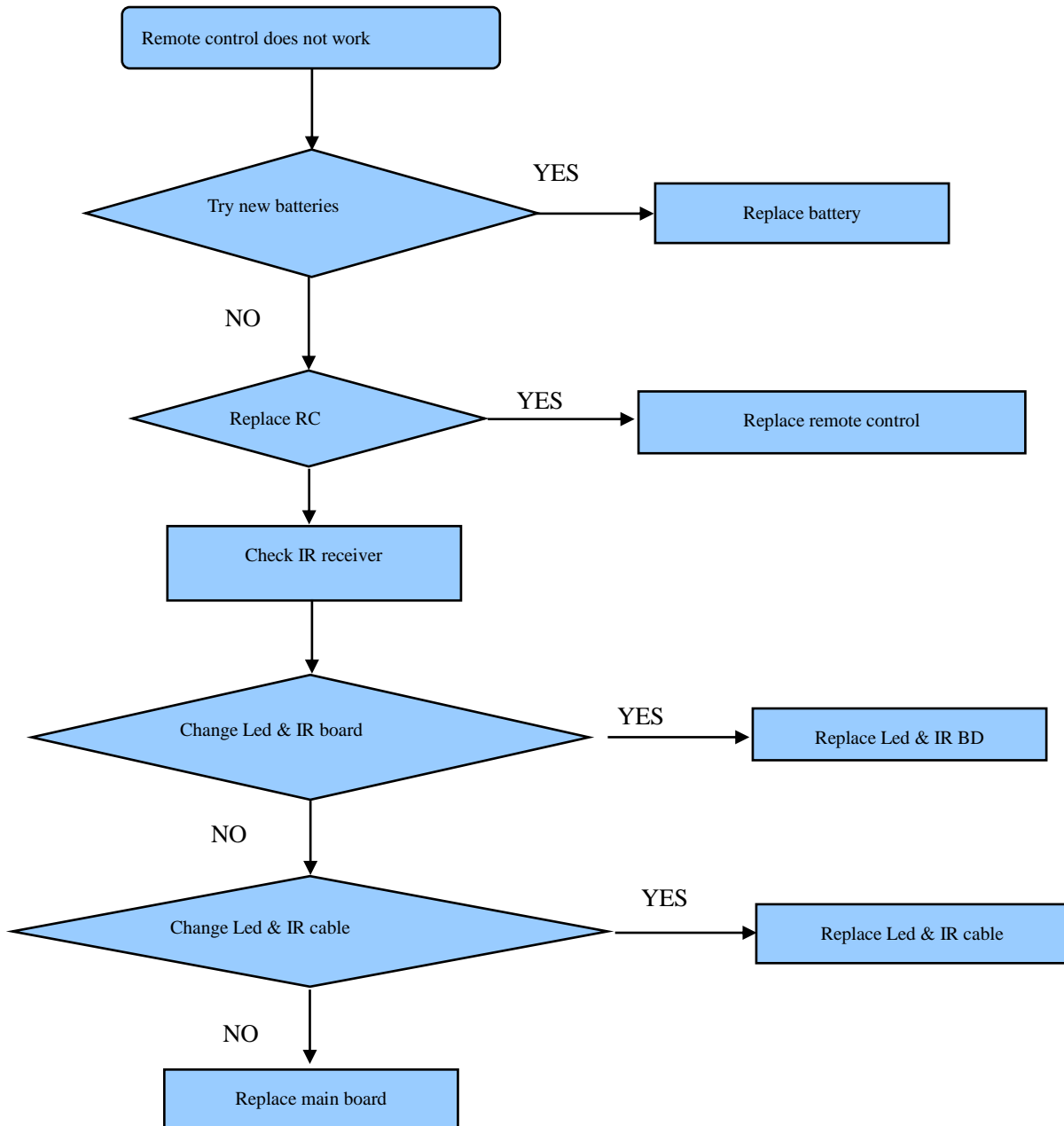

5.2 Troubleshooting for Function Key

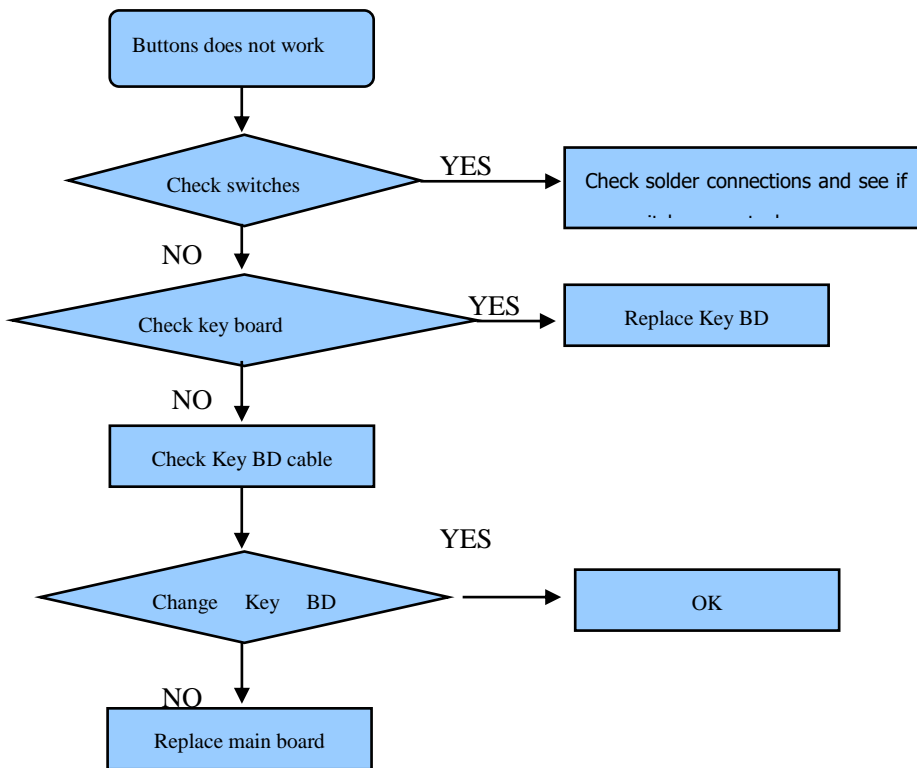

5.3 TV won't Power On

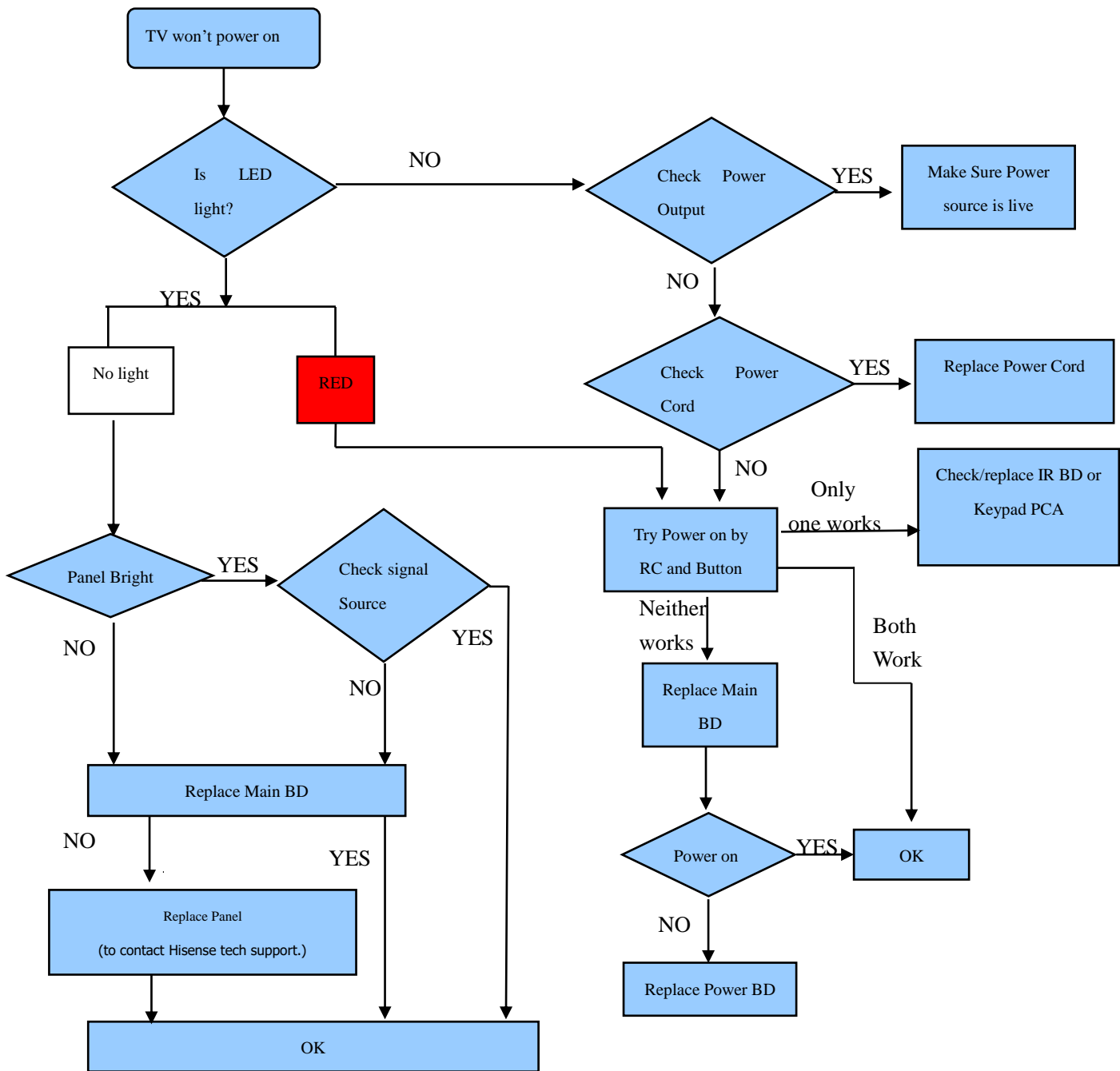

Notice:

Chassis MTK9602
 When TV Standby ,the indicated led is red
 When TV normal ,the indicated led is no light..

5.4 Troubleshooting for Audio

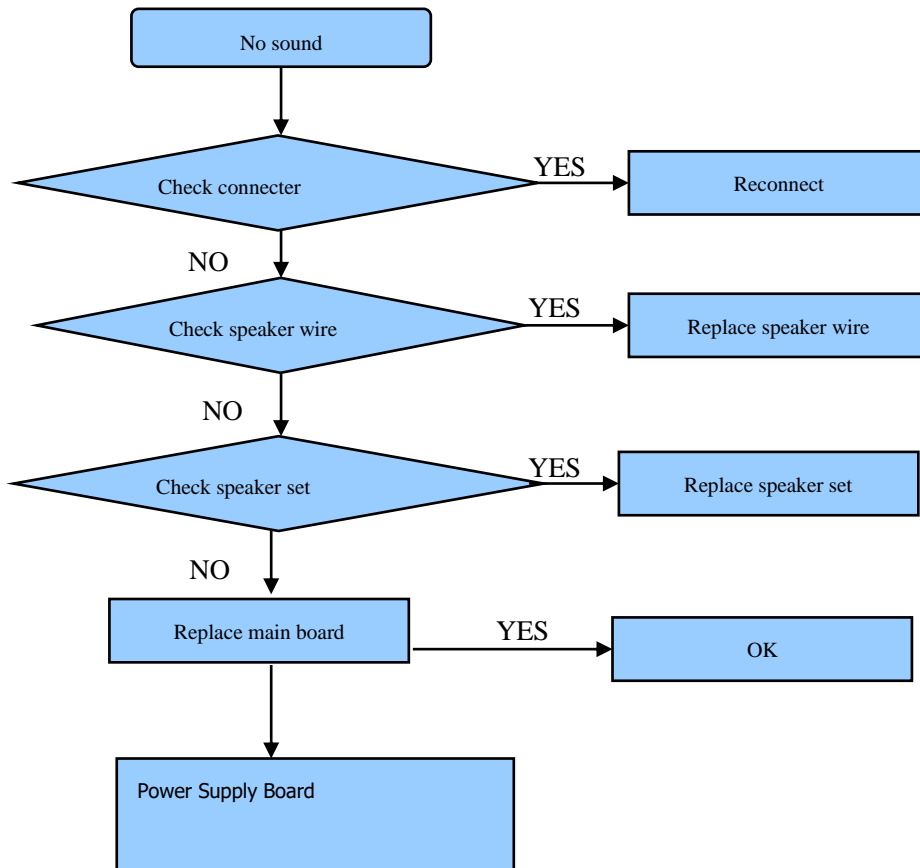

5.5 Troubleshooting for TV/HDMI input

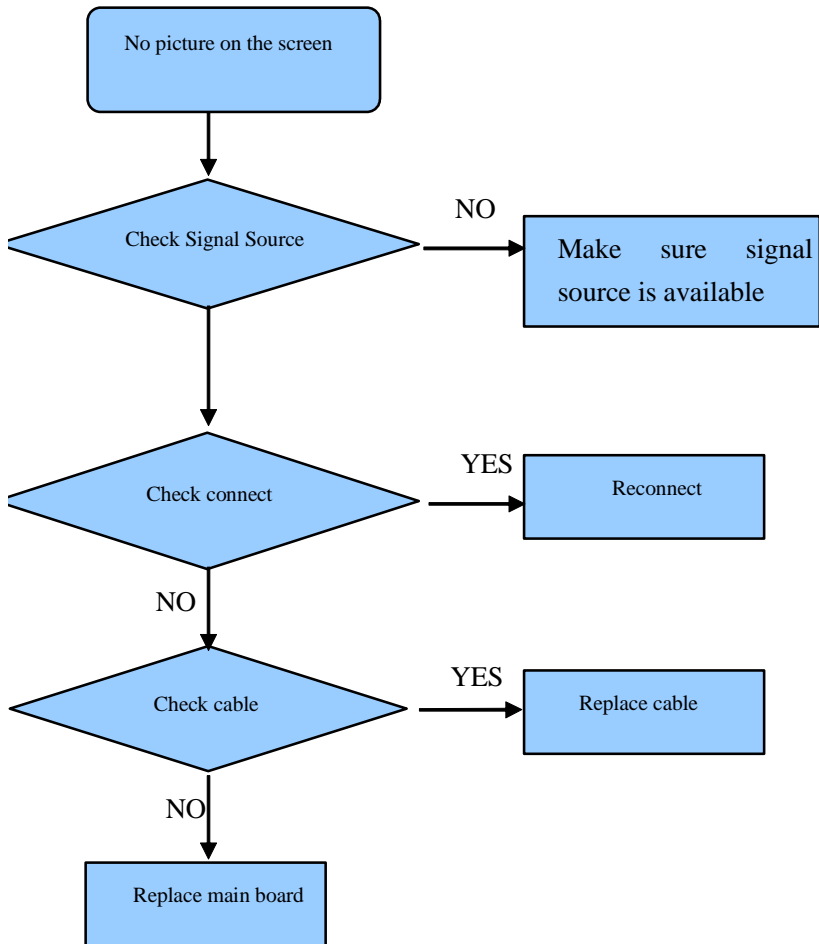

5.6 Troubleshooting for Video input

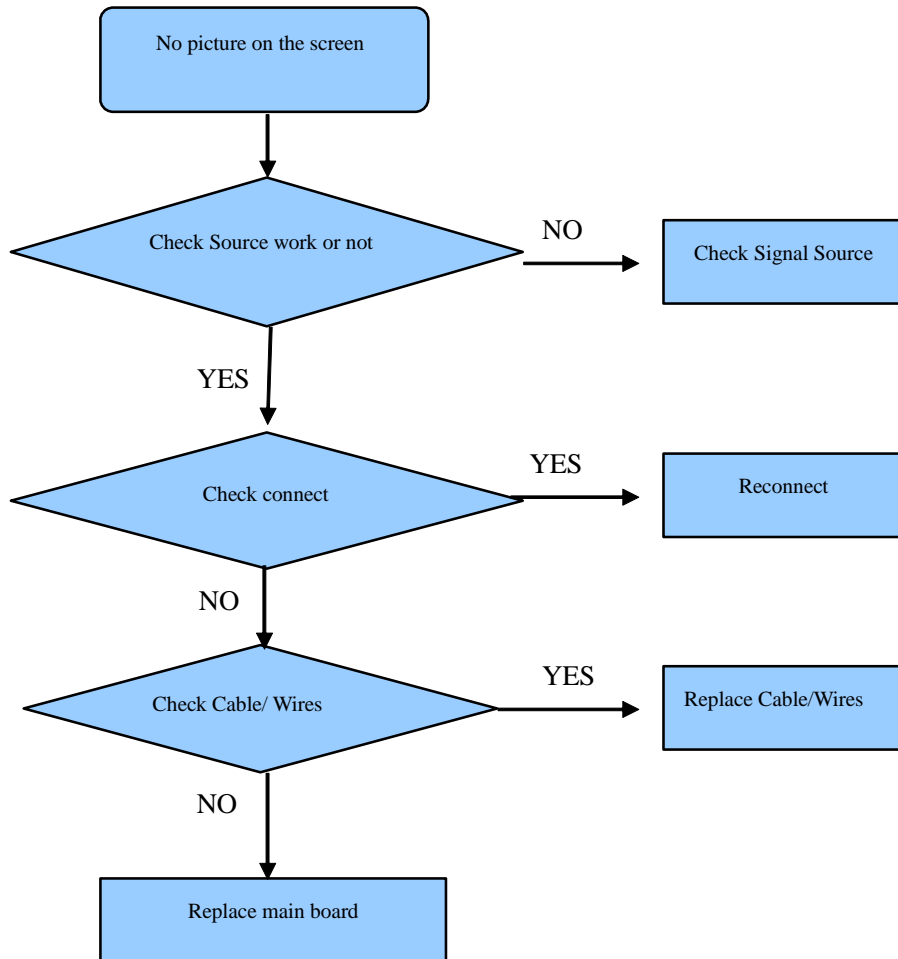

6. Signals Block Diagram & power assign & schematic diagram